

RKF Series



Total Motion Control

Harmonic Drive actuator

Precision Gearing & Motion Control

RKF Series

The RKF series is compact and includes high-torque AC servo actuators with high rotational accuracy and flange output combining a speed reducer Harmonic Drive™ for precision control and an AC servo motor. This is combined with a dedicated servo driver that fully demonstrates the performance of this RKF series of implements; compact machines and equipment with a high rotational accuracy.



Features

- **High resolution**

High resolution of maximum 800,000 pulses / revolution (0.00045°/pulse) using a Harmonic Drive™.

- **High positional accuracy**

The Harmonic Drive™ eliminates backlash caused by gear play, ensuring high-accuracy positioning.

- **Easy-to-operate dedicated driver**

A dedicated driver is set with parameters for a combined actuator. Host system parameters and control parameters can be easily set on a 7-segment LED display.

Models and Symbols

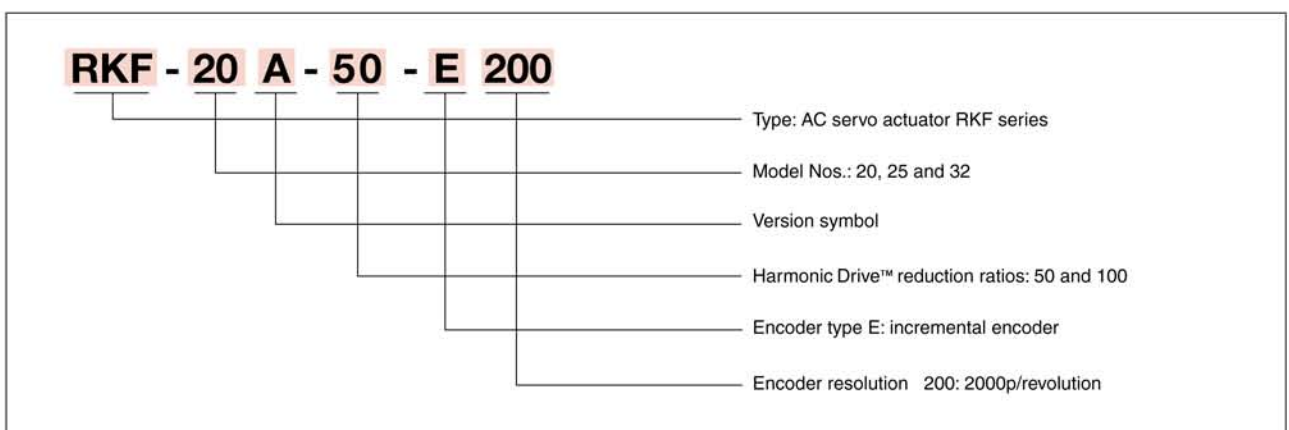

AC servo actuator

Specification

Time rating:	Continuous	Insulation resistance:	DC500V 100M ohm or higher	Ambient temperature:	0 to 40°C
Excitation method:	Permanent magnet	Structure:	Totally enclosed, self-cooled	Storage temperature:	-20°C to +60°C
Insulation class:	Class B	Dielectric strength:	AC1000V/min	Ambient humidity:	20~80% (no condensation)
Dielectric strength:	AC1000V/min	Insulation resistance:	DC500V 100M ohm or higher	Resistance to vibration:	25m/s ²
		Structure:	Totally enclosed, self-cooled	Lubricant:	Grease (Harmonic grease)

Item		Model	RKF-20A		RKF-25A		RKF-32A	
			50	100	50	100	50	100
Rated Output	W		120	111	180	190	310	310
Input Power Supply	V		AC200					
Rated Torque	Nm		19	35	29	59	49	98
	Inlb		168	310	257	522	434	867
Rated Rotational Speed	r/min		60	30	60	30	60	30
Continuous Stall Torque	Nm		19	35	29	59	49	98
	Inlb		168	310	257	522	434	867
Maximum Momentary Torque	Nm		56	82	98	157	220	330
	Inlb		496	726	867	1389	1947	2921
Max. Rotational Speed	r/min		90	45	90	45	90	45
Moment of Inertia	kgm ²		0.098	0.39	0.19	0.77	0.67	2.7
	kgfcms ²		1.0	4.0	2.0	7.9	6.9	27
Reduction Ratio			50	100	50	100	50	100
Permissible Radial Load	N		2000		2500		3900	
	Lbf		450		562		877	
Permissible Thrust Load	N		880		1100		1600	
	Lbf		198		247		360	
Detector Resolution (At x4) *5	Pulses/revolution		400,000	800,000	400,000	800,000	400,000	800,000
Mass	Kg		2.9		5.0		9.5	
Servo Drive Combinations	AC 200		RTL-230-18, REL-230-18					
			HA-520-1R-200 HA-655-2B-200		HA-520-3-200 HA-655-2B-200		HA-655-4B-200	

* 1: The aforementioned values are those at the output shaft including the Harmonic Drive™ efficiency.

* 2: The actuator specification is the value when mounted on the following aluminum radiation plate:
RKF-20: 250 x 250 x 12mm
RKF-25, RKF-32: 300 x 300 x 15mm

* 3: The values are those on temperature rise saturation. The other values are those at 20°C.

* 4: The moment of inertia is the total of the inertia moments of the motor shaft and Harmonic Drive™ converted into the output shaft side.

* 5: Detector resolution is calculated using (Motor shaft encoder resolution) 4 x (Reduction ratio).

RKF Series

External Dimensions

■ RKF-20A

In mm

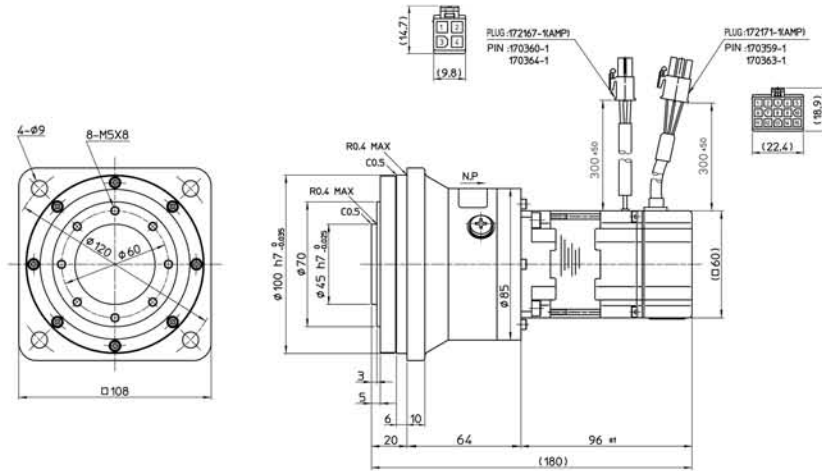

■ RKF-25A

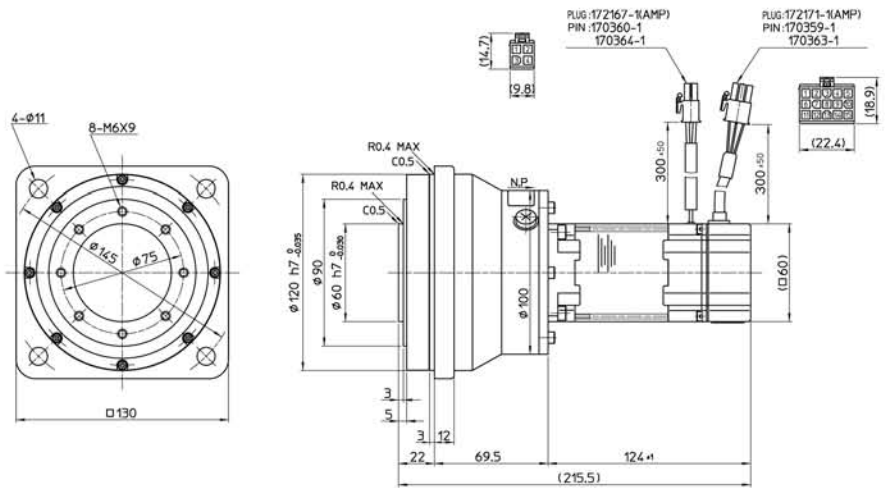

■ RKF-32A

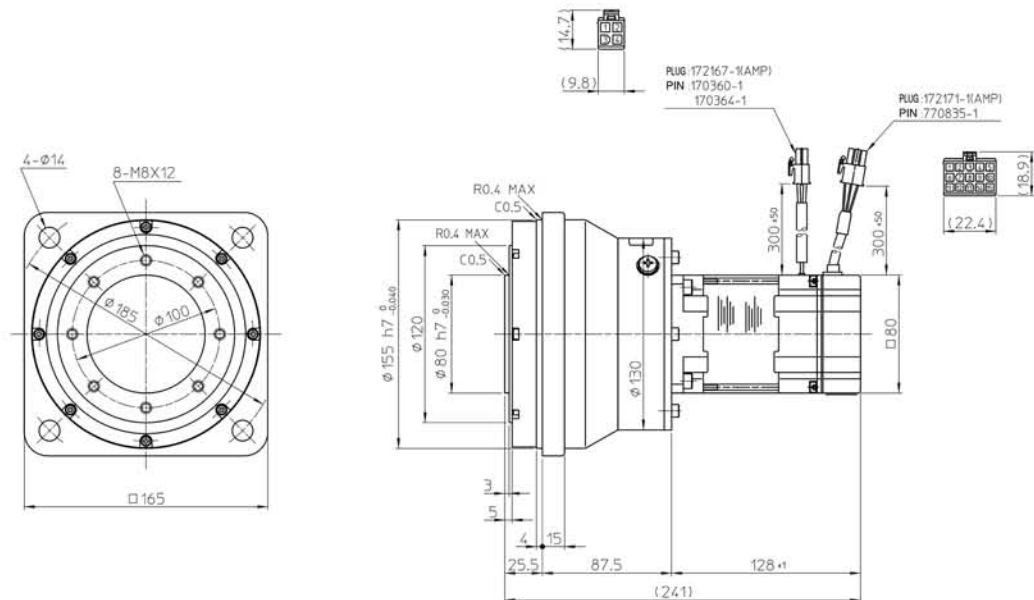

* Please confirm dimensions and shape against the illustrated specifications issued by us and accompanying the delivered product.

Positional accuracy

The "uni-directional positional accuracy" and "repeatability" are shown below. The following values represent typical values. (Source: JIS [Japanese Industrial Standards] B 6201:1987).

The RKF series contains a speed reducer Harmonic Drive™ for precision control and positioning errors of the motor shaft are therefore compressed to 1/50 or 1/100 through speed reduction. In reality, angular transmission errors of the speed reducer determine the positional accuracy. The measured values of angular transmission errors of the speed reducer are therefore shown as the positional accuracies of the RKF Series.

Item	Model	RKF-20A	RKF-25A	RKF-32A
Uni-directional Positional accuracy	arc sec	90	90	90
	rad	4.35×10^{-4}	4.35×10^{-4}	4.35×10^{-4}
Repeatability	arc sec	±30	±25	±20
	rad	$\pm 1.46 \times 10^{-4}$	$\pm 1.21 \times 10^{-4}$	$\pm 0.97 \times 10^{-4}$

<Measurement conditions. Load: no load, rotational speed: rated value>

Mechanical Accuracy

The mechanical accuracies of the output shaft and mounting flange of the RKF series are as follows.

Mechanical Accuracy		in mm		
Accuracy Item	RKF-20A	RKF-25A	RKF-32A	
1 Output shaft surface runout	0.04	0.04	0.04	
2 Output shaft end runout	0.04	0.04	0.04	
3 Eccentricity of flange fitting outside diameter	0.06	0.06	0.06	
4 Perpendicularity between surface of mounting flange and output shaft	0.06	0.06	0.06	

* The aforementioned values are TIR (total indicator reading) values.

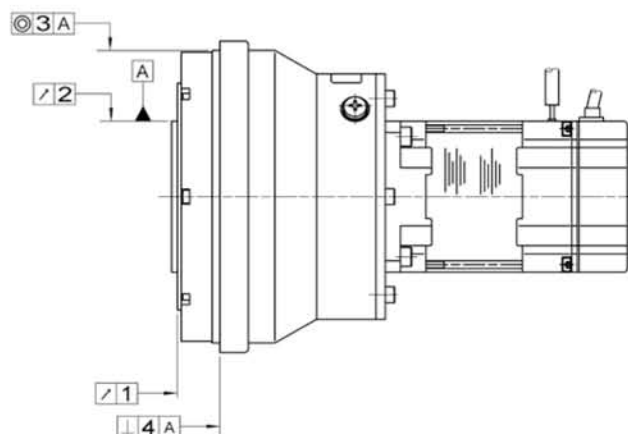

RKF Series

Operable Range

The following diagrams show the operable range of the RKF series combined with an AC servo driver (HA-520/HA-655).

Continuous motion range: Range of continuously operable torque-rotational speed .

Repetitive motion range: Range of "rotational speed - torque" that can be operated momentarily. Normally, this range is used during acceleration and deceleration.

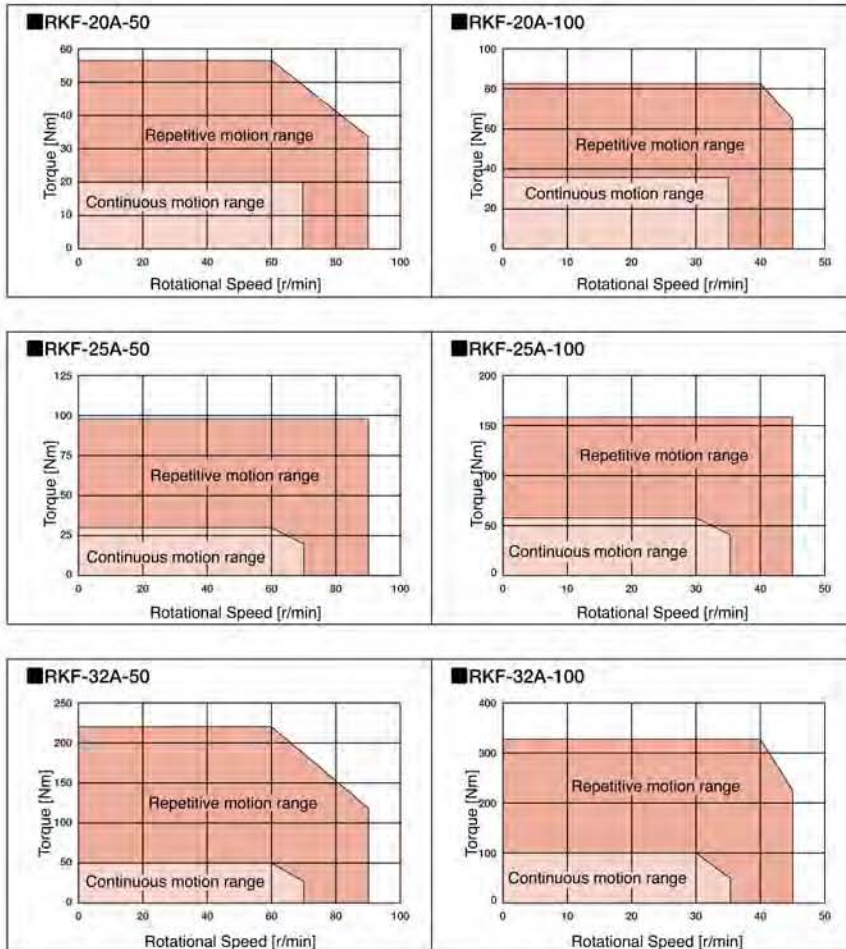

Note 1: The values in the graphs are those when one of the following aluminum radiation plates is mounted.

RKF-20: 250x250x12 (mm)
 RKF-25, RKF-32: 300x300x15 (mm)

Options

Relay Cable (For HA-520)

Order Code Example:
 EWA-M * * -A04-WG04 (For motor)
 EWA-E * * -M15-3M36 (For incremental encoder)
 The cable for connecting the actuator to the servo driver HA-520.
 Standard cable lengths are 3, 5 and 10m.

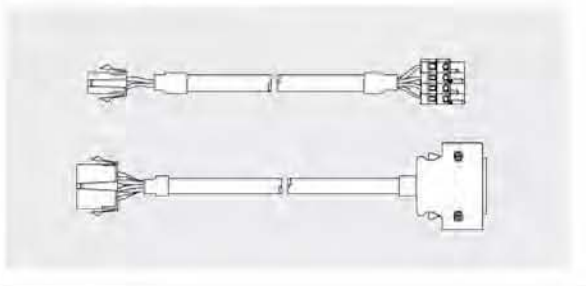

Relay Cable (For HA-655-1B)

Order Code Example:
 EWA-M * * -A04-TN (For motor)
 EWA-E * * -A15-3M14 (For incremental encoder)
 The cable for connecting the actuator to the servo driver HA-655-1B.
 Standard cable lengths are 3, 5 and 10m.

